



GAI-TRONICS® CORPORATION
A HUBBELL COMPANY

10960 Series Zone Interface Modules

Getting Started

Product Overview

Thank you for your purchase of the GAI-Tronics Zone Interface Module (ZIM). The 10960 Series ZIM models provide complimentary hardware and functionality to the 10959 Series Audio Messenger Interfaces (AMI).

Prior to installation of the ZIM, we recommend you read the entire manual and inspect the contents of the package to ensure the following are included:

- Zone Interface Module (See model chart on page 2)
- Product Evaluation Card – Please fill out and return at your earliest convenience

Features and Functions

The ZIM can be equipped with either or both of the following:

- 69502-xxx Page/Party® Interface Module
- 69451-xxx Amplifier Steering Module

The Model 10960-002 and 10960-003 Zone Interface Modules each include a Page/Party® Interface Module, which provides the capability to broadcast any audio generated by the AMI on a GAI-Tronics Page/Party® system. When coupled with an AMI equipped with a telephone interface card, the Page/Party® Interface provides telephone callers access to full-duplex party line communications.

In the event that a Page/Party® user does not answer the page within a reasonable amount of time, the telephone interface provides a re-page feature. If the caller enters a DTMF “#” while waiting for a party to answer, the system prompts the caller to make another page. For example, if the original party is not available to answer the page, the caller has the option to re-page another person.

Additionally, when the 10960 includes the Page/Party® Interface, the AMI can be configured to allow a telephone caller to direct the telephone call to a specific party line. Please see the Remote Commands section of this manual for more details.

The Page/Party[®] Interface card is equipped with circuitry to activate GAI-Tronics' VLC devices. VLC receivers can be purchased as add-on units for the 700 Series amplifiers. The VLC can override volume control settings, ensuring that the alarm is heard in all areas, regardless of the volume control adjustment of individual amplifiers. VLC transmitter activation can be programmed for any or all of the alarm inputs. This feature allows only the specified, higher priority alarms to override all volume control settings, while lower priority tones do not.

The Model 10960-001 and 10960-003 ZIM units are both equipped with an Amplifier Steering Module. The Amplifier Steering Module provides the capability for a ZIM to route audio to eight individually controlled zones. Each zone audio output provides a 0 dBm/600-ohm output. Zones can be assigned to zone groups via the ACT tool. A maximum of 60 zone groups can be created. Each zone group has a unique description, and can consist of any combination of output zones. The ACT tool provides configuration of zone groups, which can then be assigned to various events and messages. Via the remote control function, the caller has the option of choosing the zone group destination prior to making a page. Please refer to the Remote Commands section on page 8 of this manual for more details.

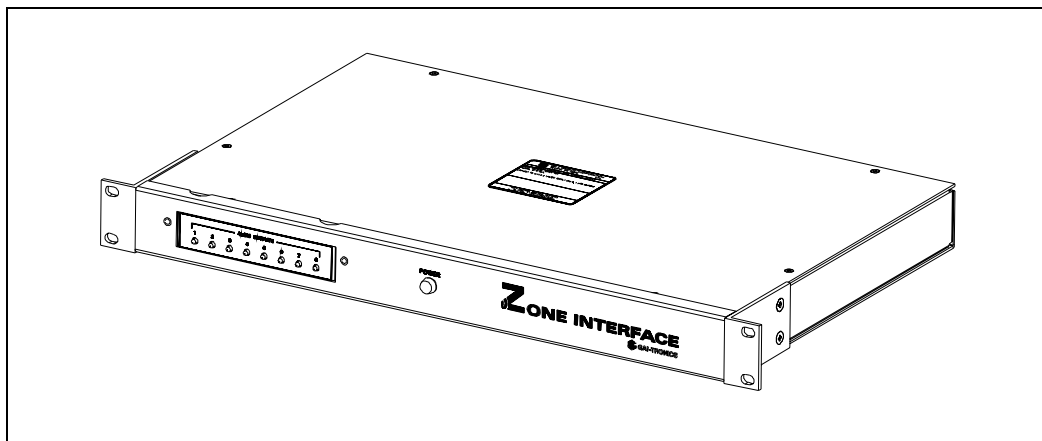

Figure 1. Zone Interface Module

GAI-Tronics 10960 Series Zone Interface Module Model Chart

Model	Description
10960-001	Zone Interface Module with 8-Zone Amplifier Steering Module
10960-002	Zone Interface Module with 33-ohm Page/Party [®] Interface
10960-003	Zone Interface Module with 8-Zone Amplifier Steering Module and 33-ohm Page/Party [®] Interface

Specifications

Power Supply Requirements

Connection to a 12 to 24 V dc (UL listed) Class 2 power source 1 amp minimum
 Power consumed 10 watts maximum

Mechanical

Enclosure Steel body with aluminum cover; black, fine-textured paint finish
 Mounting Rack-mount; 1U in standard 19-inch
 Dimensions 17.00 W × 11.18 D × 1.72 H inches; (432 × 284 × 44 mm)
 Weight 8.5 lbs. (3.86 kg)

Environmental

Temperature range..... +32° F to +122° F (0° C to +50° C)

Installation



Power Disconnect. The power cord is the main power disconnect for all units.



Disjonction de l'alimentation. Le cordon d'alimentation est la disjonction d'alimentation principale tous les appareils.



Para Desconectar la Alimentación: El cable de alimentación es el medio principal de desconexión del equipo.



Netzanschluß. Wenn man das Netzkabel aus der Steckdose zieht, dann ist die Spannungszuführung zum Gerät vollkommen unterbrochen.



CAUTION



To reduce the risk of fire, use only No. 26 AWG or larger telecommunication line cord.



ATTENTION



Pour réduire le risque d'incendie, utiliser uniquement des conducteurs de télécommunications 26 AWG ou de section supérieure.



PRECAUCIÓN



Para aminorar la posibilidad de incendios, utilice solamente cable de telecomunicaciones de calibre 26 (sistema AWG americano) o mayor.



VORSICHT



Um die Brandgefahr zu verringern, verwenden Sie bitte nur Fernmeldekabel der Stärke Nr. 26 AWG oder höher.

Mounting



The Model 10960 Series Rack-Mount ZIM units can be placed on a table or desk, or it can be mounted in a standard EIA 19-inch electronic equipment rack. The ZIM units require 1U (1.75 inches) in a standard 19-inch rack. If the ZIM is installed in an electronic equipment rack, complete the following steps:

1. Install the mounting brackets with the eight 8–32 × 3/8-inch screws provided.
2. Mount the ZIM into the rack using the four 10–32 × 3/4-inch screws provided.



Tabletop Mounting

If the ZIM is to be placed on a table or desk, install the five stabilizing feet and use the four #4 countersunk toothed washers when attaching the top to the base. These washers help to provide good contact between the two to ensure adequate grounding.

Wiring

 **WARNING**  Do not apply power until all the connections have been wired.

 Warning: Observe precautions for handling electrostatic sensitive devices.

 **WARNING**  Connect only to a UL-listed Class 2 power source.

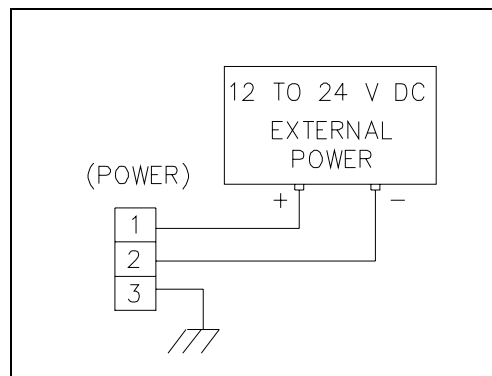



Figure 2. Power connections

Label	Description	Function
+	Power (+)	12 to 24 V dc power supply positive terminal
-	Power (-)	12 to 24 V dc power supply negative terminal
	Ground	Earth ground

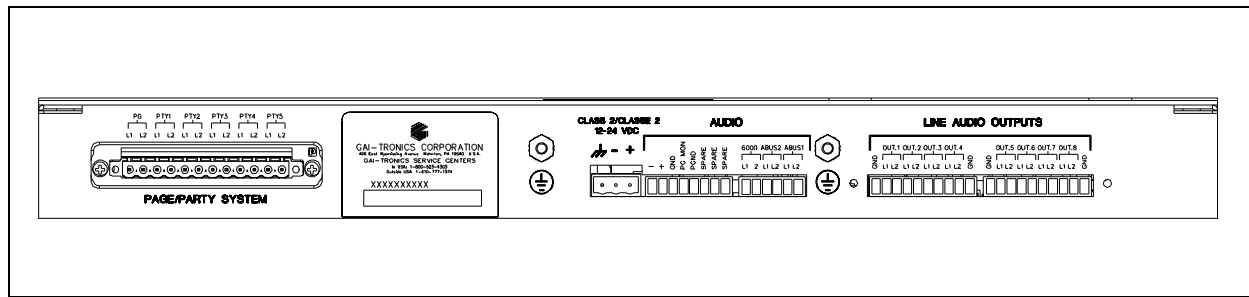

Figure 3. ZIM Rear Panel

Audio (Communication)

Terminal	Labeled	Description	Function
1	-	Data (-)	Connect to AMI Models 10959-xxx (TB3-9)
2	+	Data (+)	Connect to AMI Models 10959-xxx (TB3-10)
3	GND	Data (Gnd)	Connect to AMI Models 10959-xxx (TB3-8)
4	PG MON	Page monitor	No connection (future use)
5	PGND	Power ground	Connect to AMI Models 10959-xxx (TB3-7)
6	SPARE	Spare	No connection
7	SPARE	Spare	No connection
8	SPARE	Spare	No connection

Audio

Terminal	Labeled	Description	Function
1	600Ω (L1)	Page (L1)	Connect to AMI Models 10959-xxx (TB3-1)
2	600Ω (L2)	Page (L2)	Connect to AMI Models 10959-xxx (TB3-2)
3	AUDIO2 (L1)	Audio 2 (L1)	Connect to AMI Models 10959-xxx (TB3-3)
4	AUDIO2 (L2)	Audio 2 (L2)	Connect to AMI Models 10959-xxx (TB3-4)
5	AUDIO1 (L1)	Audio 1 (L1)	Connect to AMI Models 10959-xxx (TB3-5)
6	AUDIO1 (L2)	Audio 1 (L2)	Connect to AMI Models 10959-xxx (TB3-6)

Line Audio Outputs 1

Terminal	Labeled	Description	Function
1	GND	Power ground	
2	OUT 1 (L1)	Audio out Zone 1 (L1)	Zone 1 Output Balanced 600 Ω
3	OUT 1 (L2)	Audio out Zone 1 (L2)	
4	OUT 2 (L1)	Audio out Zone 2 (L1)	Zone 2 Output Balanced 600 Ω
5	OUT 2 (L2)	Audio out Zone 2 (L2)	
6	OUT 3 (L1)	Audio out Zone 3 (L1)	Zone 3 Output Balanced 600 Ω
7	OUT 3 (L2)	Audio out Zone 3 (L2)	
8	OUT 4 (L1)	Audio out Zone 4 (L1)	Zone 4 Output Balanced 600 Ω
9	OUT 4 (L2)	Audio out Zone 4 (L2)	
10	GND	Power ground	

Line Audio Outputs 2

Terminal	Labeled	Description	Function
1	GND	Power ground	
2	OUT 5 (L1)	Audio out Zone 5 (L1)	Zone 5 Output - Balanced - 600 Ω
3	OUT 5 (L2)	Audio out Zone 5 (L2)	
4	OUT 6 (L1)	Audio out Zone 6 (L1)	Zone 6 Output - Balanced - 600 Ω
5	OUT 6 (L2)	Audio out Zone 6 (L2)	
6	OUT 7 (L1)	Audio out Zone 7 (L1)	Zone 7 Output - Balanced - 600 Ω
7	OUT 7 (L2)	Audio out Zone 7 (L2)	
8	OUT 8 (L1)	Audio out Zone 8 (L1)	Zone 8 Output - Balanced - 600 Ω
9	OUT 8 (L2)	Audio out Zone 8 (L2)	
10	GND	Power ground	

Page/Party® System

Terminal	Labeled	Description	Function
1	PG (L1)	Page (L1)	Connects to the page line of Page/Party® system
2	PG (L2)	Page (L2)	
3	PTY1 (L1)	Party 1 (L1)	Connects to the party 1 line of Page/Party® system
4	PTY1 (L2)	Party 1 (L2)	
5	PTY2 (L1)	Party 2 L1)	Connects to the party 2 line of Page/Party® system
6	PTY2 (L2)	Party 2 (L2)	
7	PTY3 (L1)	Party 3 (L1)	Connects to the party 3 line of Page/Party® system
8	PTY3 (L2)	Party 3 (L2)	
9	PTY4 (L1)	Party 4 (L1)	Connects to the party 4 line of Page/Party® system
10	PTY4 (L2)	Party 4 (L2)	
11	PTY5 (L1)	Party 5 (L1)	Connects to the party 5 line of Page/Party® system
12	PTY5 (L2)	Party 5 (L2)	

Setup

Preparation

When the unit is ready for testing, please ensure the ZIM is installed and connections are made consistent with the Wiring section on page 4. Please verify the following:

- DC power connected and polarity is correct
- Inputs are connected
- Outputs are connected
- Phone line is connected (if applicable)
- Page and party lines are connected (if applicable)
- Paging amplifier is connected (if using 600-ohm output)
- Resistive line balance is installed to support the Page line.
- Existing party line resistive line balancing is disconnected.

Operation

Remote Commands

After a call has been connected to the AMI with a ZIM, the caller can enter a valid remote command using the DTMF keypad of the telephone. During the greeting message, the caller must enter a DTMF “*” to access remote control. The greeting message will be halted, and two consecutive beeps will sound, indicating the unit has entered remote control mode.

Callers can direct a page to a specific zone group by entering a DTMF “#”, followed by the two-digit zone group number. Valid zone group numbers are 01 - 60. Entering #00 selects the all-call feature.

Additional remote commands are available for wall-mount AMI units equipped with the 33-ohm Page/Party® Interface. Callers can choose the party line that will be connected for a subsequent telephone conversation. After entering remote control mode, the caller enters a DTMF “*”, followed by the single-digit party line (1 through 5). The AMI will continue with live page or recorded paging, depending upon the configured page mode. When the page is answered, the caller is connected to the selected party line.

The Off-hook Timeout setting for the Telephone Interface in the ACT tool limits the duration of a party conversation. Approximately 20 seconds prior to the configured timeout expiration, the AMI will emit a warning tone, indicating that the connected call is about to be terminated. If the caller enters the DTMF “*” key, the AMI extends the conversation by the length of time defined by the Off-hook Timeout parameter. Two consecutive beeps are sounded when the AMI timeout has been successfully extended.

While a caller is waiting for the paged party to respond, entering the DMTF “#” causes the AMI to restart paging. Callers can either reissue a page for the original party, or make a page for another party.

NOTE: The caller does not access remote control mode to extend the connected party conversation or to reissue a page.

Maintenance

If your ZIM unit requires service, contact your GAI-Tronics Regional Service Center for a return authorization number (RA#). Equipment should be shipped prepaid to GAI-Tronics with a return authorization number and a purchase order number. If the equipment is under warranty, repairs will be made without charge. Please include a written explanation of all defects to assist our technicians in their troubleshooting efforts.

Call 800-492-1212 inside the USA or 610-777-1374 outside the USA for help identifying the Regional Service Center closest to you.

Description of Major Components

Internal Components

The ZIM contains the PCBAs as listed below. Refer to Figure 4 for mounting locations.

- Amplifier Steering Module PCBA
- LED Module
- Power Supply PCBA
- Page/Party® Interface PCBA

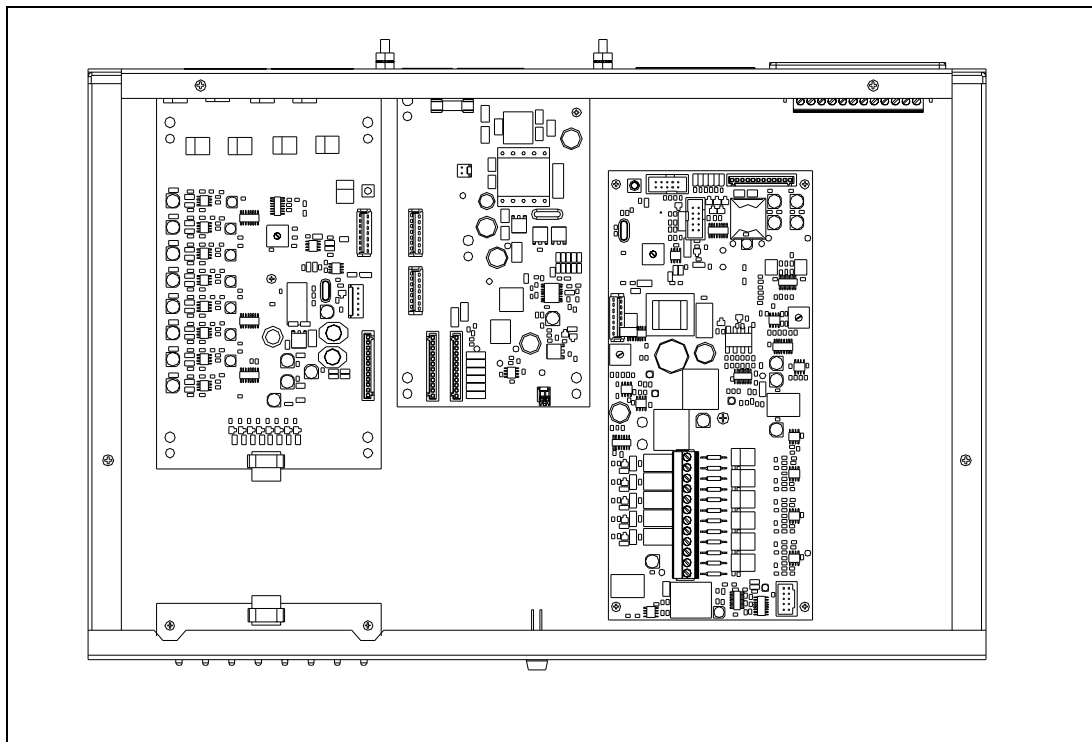

Figure 4. Model 10960-003 Zone Interface Module - Interior

Internal Cable Connections

The following is a matrix showing the connections for the ZIM internal components:

PCBA/Component	Connector Matrix						
Amplifier Steering Module PCBA	P4		P2		P3		
LED Module					P5		
Power Supply PCBA	P4	P41	PS501	PS502			P6
Page/Party® Interface PCBA		P5		P4		TB1	
Enclosure						(Rear) P/P system	(Front) Power LED

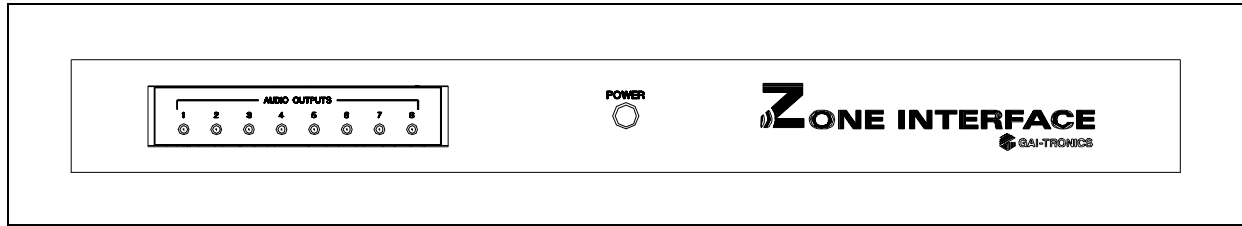

Figure 5. ZIM Front Panel

Audio Output LEDs

The front panel Audio Output LEDs (1 through 8) indicate which of the ZIM's eight audio paths are currently open.

Power LED

The ZIM unit's front panel power LED indicates that an external power supply (12 to 24 V dc) is connected.

Replacement Parts

Part Number	Description
69451-001	Amplifier Steering Module
69452-001	Auxiliary Power Module
69502-101	Page/Party [®] Interface Module
Wall Pack	120 V ac/12 V dc @ 1 A

Confidentiality Notice

This manual is provided solely as an operational, installation, and maintenance guide and contains sensitive business and technical information that is confidential and proprietary to GAI-Tronics. GAI-Tronics retains all intellectual property and other rights in or to the information contained herein, and such information may only be used in connection with the operation of your GAI-Tronics product or system. This manual may not be disclosed in any form, in whole or in part, directly or indirectly, to any third party.