

REVISION			
REV.	DESCRIPTION	ENGR. APVD.	DATE
D	PER EN #97-100 / SMM	AS	6/4/87
E	PER EN #91-483 / KPT / RLA	BBP	10/9/91
F	REV. PER EDN #03-387 / NSW	KAS	2/3/04

THIS DOCUMENT AND ITS CONTENTS ARE THE PROPERTY OF GAI-TRONICS CORPORATION (GTC), AND SHALL NOT BE REPRODUCED, COPIED, EITHER WHOLLY OR IN PART, WITHOUT THE EXPRESS WRITTEN CONSENT OF GTC. DISCLOSE, DIRECTLY OR INDIRECTLY, IN WHOLE OR IN PART, THE DOCUMENT/CONTENTS TO ANY PERSON OR ENTITY, AND SHALL NOT USE, IN WHOLE OR IN PART, THE DOCUMENT/CONTENTS, EXCEPT STRICTLY AS AUTHORIZED BY GTC.

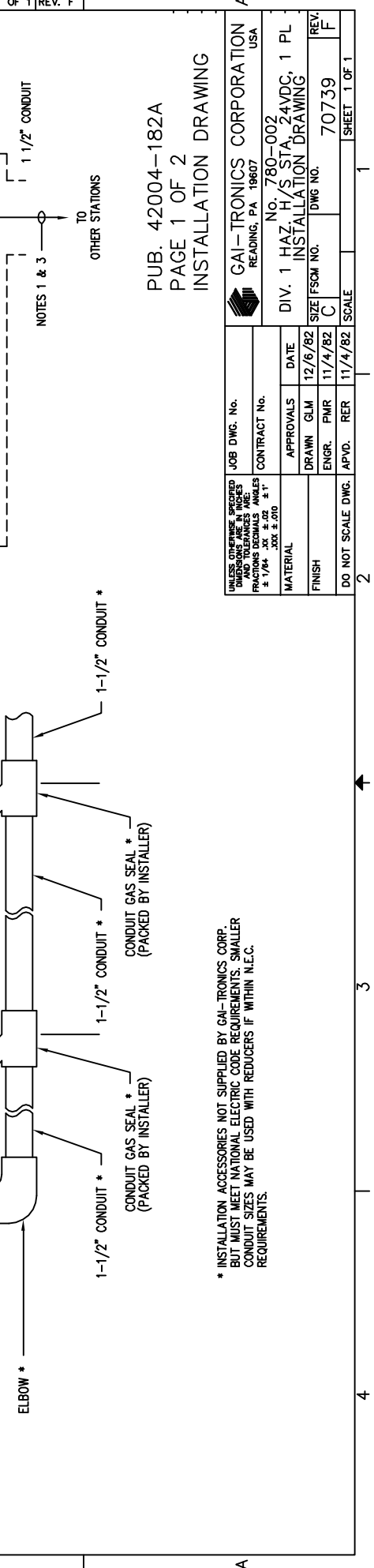
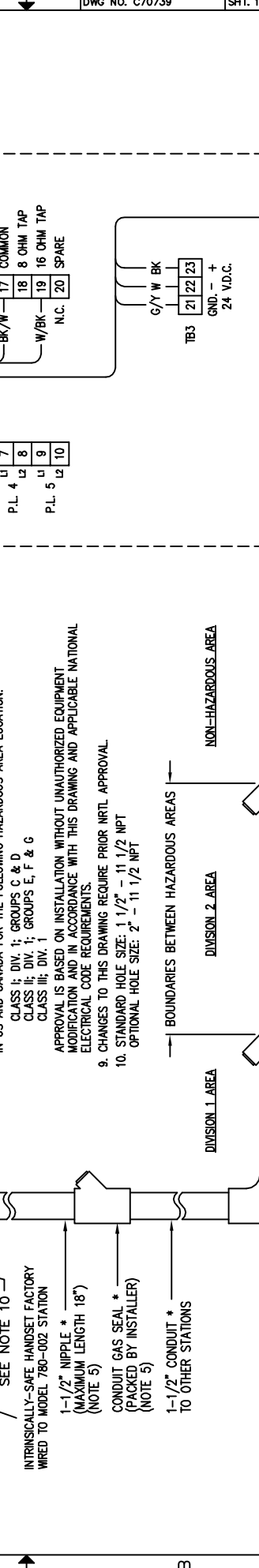
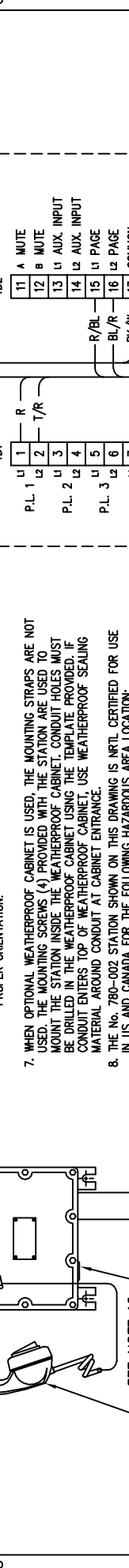
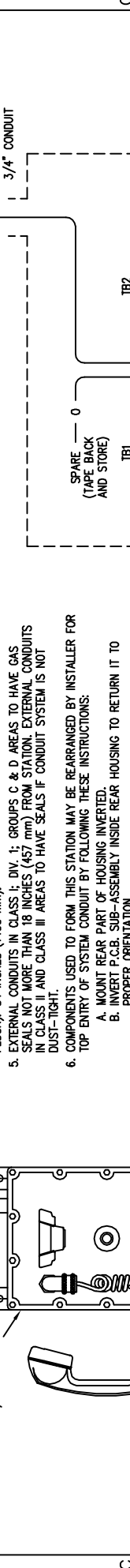

NOTES:

- COLOR CODE OF SYSTEM CABLE BASED ON GAI-TRONICS CORP. No. 60038-101 8-CONDUCTOR CABLE.
- COLOR CODE OF SPEAKER CABLE BASED ON GAI-TRONICS CORP. No. 60021-301 2-CONDUCTOR CABLE (TWISTED PAIR #18 AWG). CONNECTION SHOWN FOR 16 OHM SPEAKER. MOVE W/BK WIRE FROM TERMINAL #19 TO TERMINAL #18 FOR 8 OHM SPEAKER.
- THE NOTATION COLOR #1/ COLOR #2 (e.g. R/BL) DENOTES BASIC WIRE COLOR #1 WITH COLOR #2 STRIPE.
- SUGGESTED MOUNTING HEIGHT OF STATION (FROM CENTERLINE OF STATION TO FLOOR): 54 INCHES (1400 mm).
- EXTERNAL CONDUITS IN CLASS I; DIV. 1; GROUPS C & D AREAS TO HAVE GAS SEALS NOT MORE THAN 18 INCHES (457 mm) FROM STATION. EXTERNAL CONDUITS IN CLASS II AND CLASS III AREAS TO HAVE SEALS IF CONDUIT SYSTEM IS NOT DUST-TIGHT.
- COMPONENTS USED TO FORM THIS STATION MAY BE REARRANGED BY INSTALLER FOR TOP ENTRY OF SYSTEM CONDUIT BY FOLLOWING THESE INSTRUCTIONS:
 - MOUNT REAR PART OF HOUSING INVERTED.
 - INVERT P.C.B. SUB-ASSEMBLY INSIDE REAR HOUSING TO RETURN IT TO PROPER ORIENTATION.
- WHEN OPTIONAL WEATHERPROOF CABINET IS USED, THE MOUNTING STRAPS ARE NOT USED. THE MOUNTING SCREWS (4) PROVIDED WITH THE STATION ARE USED TO MOUNT THE STATION INSIDE THE WEATHERPROOF CABINET. CONDUIT HOLES MUST BE DRILLED IN THE WEATHERPROOF CABINET USING THE TEMPLATE PROVIDED. IF CONDUIT ENTERS TOP OF WEATHERPROOF CABINET, USE WEATHERPROOF SEALING MATERIAL AROUND CONDUIT AT CABINET ENTRANCE.
- THE No. 780-002 STATION SHOWN ON THIS DRAWING IS NRTL CERTIFIED FOR USE IN US AND CANADA FOR THE FOLLOWING HAZARDOUS AREA LOCATION:
 - CLASS I; DIV. 1; GROUPS C & D
 - CLASS II; DIV. 1; GROUPS E, F & G
 - CLASS III; DIV. 1
- APPROVAL IS BASED ON INSTALLATION WITHOUT UNAUTHORIZED EQUIPMENT MODIFICATION AND IN ACCORDANCE WITH THIS DRAWING AND APPLICABLE NATIONAL ELECTRICAL CODE REQUIREMENTS.
- CHANGES TO THIS DRAWING REQUIRE PRIOR NRTL APPROVAL.
- STANDARD HOLE SIZE: 1 1/2" - 11 1/2 NPT
OPTIONAL HOLE SIZE: 2" - 11 1/2 NPT

* INSTALLATION ACCESSORIES NOT SUPPLIED BY GAI-TRONICS CORP. BUT MUST MEET NATIONAL ELECTRIC CODE REQUIREMENTS. SMALLER CONDUIT SIZES MAY BE USED WITH REDUCERS IF WITHIN N.E.C. REQUIREMENTS.

UNLESS OTHERWISE SPECIFIED: DIMENSIONS IN INCHES FRACTIONS DECIMALS ANGLES ± 1/64" .XX ± .02 .XXX ± .01

DO NOT SCALE DWG. APVD. RER 11/4/82 SCALE SHEET 1 OF 1

JOB DWG. No. CONTRACT No. No. 780-002 DIV. 1 HAZ. AREA STA. 24VDC, 1 PL INSTALLATION DRAWING

GAI-TRONICS CORPORATION READING, PA 19807 USA

PUB. 42004-182A PAGE 1 OF 2 INSTALLATION DRAWING

THIS DOCUMENT AND ITS CONTENTS ARE THE PROPERTY OF GAI-TRONICS CORPORATION (GTC), AND SHALL NOT BE REPRODUCED, COPIED, EITHER WHOLLY OR IN PART, WITHOUT THE EXPRESS WRITTEN CONSENT OF GTC. DISCLOSE, DIRECTLY OR INDIRECTLY, IN WHOLE OR IN PART, THE DOCUMENT/CONTENTS TO ANY PERSON OR ENTITY, AND SHALL NOT USE, IN WHOLE OR IN PART, THE DOCUMENT/CONTENTS, EXCEPT STRICTLY AS AUTHORIZED BY GTC.

REVISION	
REV.	DESCRIPTION
D	PER EN #97-100 / SMM
E	PER EN #91-482 / KPT / RLA
F	REV. PER EDN #03-38B / NSW

ENGR.	APVD.	DATE
AS		6/4/87
BBP		10/9/91
KAS	JUP	2/3/04

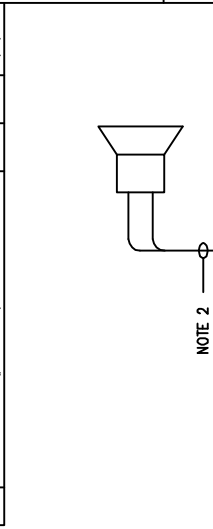

TB2	
11	A MUTE
12	B MUTE
13	U AUX. INPUT
14	L2 AUX. INPUT
15	U PAGE
16	L2 PAGE
17	COMMON
18	B OHM TAP
19	16 OHM TAP
20	SPARE

TB3	
21	G/Y W BK
22	
23	
GND. - +	
24 V.D.C.	

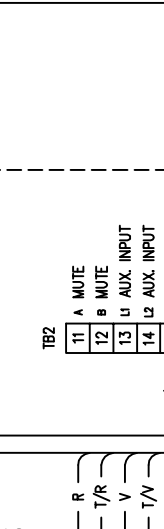

TBI	
1	L1
2	L2
3	L3
4	L4
5	L5
6	L6
7	L7
8	L8
9	L9
10	L10

P.L.	
1	R
2	T/R
3	V
4	T/V
5	BL
6	T/BL
7	BR
8	T/BR
9	Y
10	T/Y

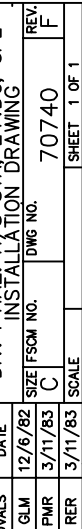
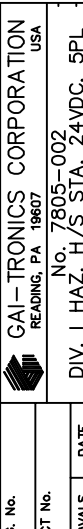
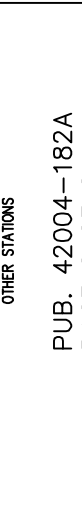
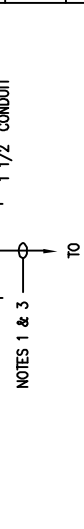
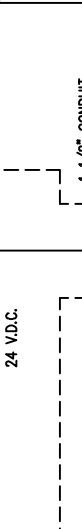
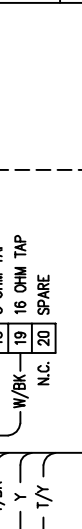

NOTES:

- COLOR CODE OF SYSTEM CABLE BASED ON GAI-TRONICS CORP. No. 60029-101 16-CONDUCTOR CABLE. WHERE STATIONS CAN BE SAFELY GROUNDED LOCALLY, No. 60024-201 14-CONDUCTOR CABLE (LACKING GREEN AND ORANGE CONDUCTORS) MAY BE USED.
- COLOR CODE OF SPEAKER CABLE BASED ON GAI-TRONICS CORP. No. 60021-301 2-CONDUCTOR CABLE (TWISTED PAIR #18 AWG) CONNECTION SHOWN FOR 16 OHM SPEAKER. MOVE W/BK WIRE TO TERMINAL #18 FOR 8 OHM SPEAKER.
- THE NOTATION COLOR #1/ COLOR #2 (e.g. R/BL) DENOTES BASIC WIRE COLOR #1 WITH COLOR #2 STRIPE.
- SUGGESTED MOUNTING HEIGHT OF STATION (FROM CENTERLINE OF STATION TO FLOOR): 54 INCHES (1400 mm).
- EXTERNAL CONDUITS IN CLASS I; DIV. 1; GROUPS C & D AREAS TO HAVE GAS SEALS NOT MORE THAN 18 INCHES (457 mm) FROM STATION. EXTERNAL CONDUITS IN CLASS II AND CLASS III AREAS TO HAVE SEALS IF CONDUIT SYSTEM IS NOT DUST-TIGHT.
- COMPONENTS USED TO FORM THIS STATION MAY BE REARRANGED BY INSTALLER FOR TOP ENTRY OF SYSTEM CONDUIT BY FOLLOWING THESE INSTRUCTIONS:
 - MOUNT REAR PART OF HOUSING INVERTED.
 - INVERT P.C.B. SUB-ASSEMBLY INSIDE REAR HOUSING TO RETURN IT TO PROPER ORIENTATION.
- WHEN OPTIONAL WEATHERPROOF CABINET IS USED, THE MOUNTING STRAPS ARE NOT USED. THE MOUNTING SCREWS (4) PROVIDED WITH THE STATION ARE USED TO MOUNT THE STATION INSIDE THE WEATHERPROOF CABINET. CONDUIT HOLES MUST BE DRILLED IN THE WEATHERPROOF CABINET USING THE TEMPLATE PROVIDED. IF CONDUIT ENTERS TOP OF WEATHERPROOF CABINET, USE WEATHERPROOF SEALING MATERIAL AROUND CONDUIT AT CABINET ENTRANCE.
- THE No. 7805-002 STATION SHOWN ON THIS DRAWING IS NRTL CERTIFIED FOR USE IN US AND CANADA FOR THE FOLLOWING HAZARDOUS AREA LOCATION:
 - CLASS I; DIV. 1; GROUPS C & D
 - CLASS II; DIV. 1
 - CLASS III; DIV. 1

APPROVAL IS BASED ON INSTALLATION WITHOUT UNAUTHORIZED EQUIPMENT MODIFICATION AND IN ACCORDANCE WITH THIS DRAWING AND APPLICABLE NATIONAL ELECTRICAL CODE REQUIREMENTS.

9. CHANGES TO THIS DRAWING REQUIRE PRIOR NRTL APPROVAL.

10. STANDARD HOLE SIZE: 1 1/2" - 11 1/2 NPT
 OPTIONAL HOLE SIZE: 2" - 11 1/2 NPT

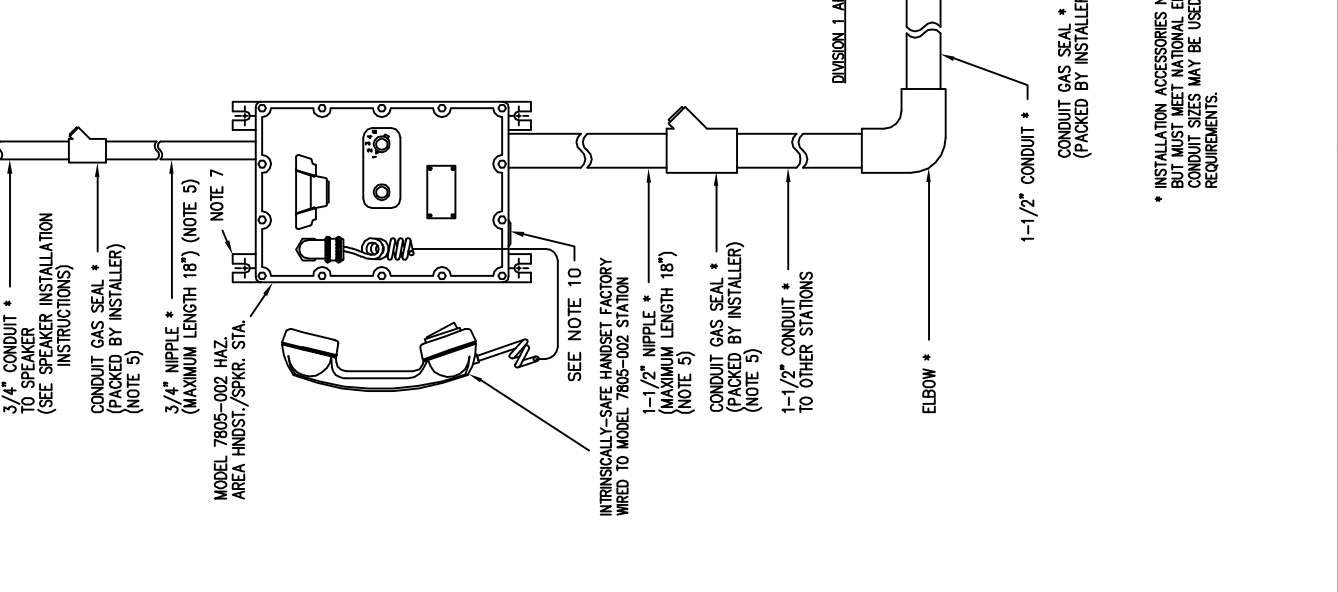

* INSTALLATION ACCESSORIES NOT SUPPLIED BY GAI-TRONICS CORP. BUT MUST MEET NATIONAL ELECTRIC CODE REQUIREMENTS. SMALLER CONDUIT SIZES MAY BE USED WITH REDUCERS IF WITHIN N.E.C. REQUIREMENTS.

PUB. 42004-182A
 PAGE 2 OF 2
 INSTALLATION DRAWING

JOB DWG. No.		CONTRACT No.	
UNLESS OTHERWISE SPECIFIED DIMENSIONS ARE IN INCHES FRACTIONS DECIMALS ANGLES ± 1/64 .XX ± .02 .XXX ± .01		APPROVALS	
MATERIAL		DATE	
FINISH		DRAWN GLM	12/6/82
DO NOT SCALE DWG.		ENGR. PMR	3/11/83
APVD. RER		3/11/83	SCALE
GAI-TRONICS CORPORATION READING, PA 19807 USA		No. 7805-002 DIV. I HAZ. H/S STA. 24VDC, 5PL INSTALLATION DRAWING	
DWG NO. 70740		REV. F	
SHEET 1 OF 1		SHEET 1 OF 1	